

NUS2401SNT1

Integrated PNP/NPN Digital Transistors Array

This new option of integrated digital transistors is designed to replace a discrete solution array of three transistors and their external resistor bias network. BRTs (Bias Resistor Transistors) contain a single transistor with a monolithic bias network consisting of two resistors; a series base resistor and a base-emitter resistor. The BRT technology eliminates these individual components by integrating them into a single device, therefore the integration of three BRTs results in a significant reduction of both system cost and board space. This new device is packaged in the SC-74/Case 318F package which is designed for low power surface mount applications.

Features

- Integrated Design
- Reduces Board Space and Components Count
- Simplifies Circuitry Design
- Offered in Surface Mount Package Technology (SC-74)
- Available in 3000 Unit Tape and Reel
- Pb-Free Package is Available

Applications

- Audio Muting Applications
- Drive Circuits Applications
- Industrial: Small Appliances, Security Systems, Automated Test
- Consumer: TVs and VCRs, Stereo Receivers, CD Players, Cassette Recorders

MAXIMUM RATINGS (Maximum ratings are those values beyond which device damage can occur. Electrical Characteristics are not guaranteed over this range.)

Rating	Symbol	Value	Unit
Collector-Base Voltage	$V_{(BR)CBO}$	60	Vdc
Collector-Emitter Voltage	$V_{(BR)CEO}$	50	Vdc
Emitter-Base Voltage	$V_{(BR)EBO}$	7.0	Vdc
Collector Current - Continuous	I_C	200	mAdc

THERMAL CHARACTERISTICS

Characteristic	Symbol	Max	Unit
Power Dissipation	P_D	350	mW
Junction Temperature	T_J	150	°C
Storage Temperature	T_{stg}	-55 to +150	°C

Stresses exceeding Maximum Ratings may damage the device. Maximum Ratings are stress ratings only. Functional operation above the Recommended Operating Conditions is not implied. Extended exposure to stresses above the Recommended Operating Conditions may affect device reliability.



ON Semiconductor®

<http://onsemi.com>

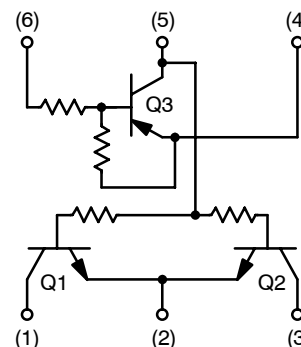

SC-74
CASE 318F
STYLE 4

MARKING DIAGRAM

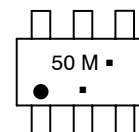

50 = Specific Device Code
M = Date Code
▪ = Pb-Free Package

(Note: Microdot may be in either location)

*Date Code orientation may vary depending upon manufacturing location.

ORDERING INFORMATION

Device	Package	Shipping†
NUS2401SNT1	SC-74	3000/Tape & Reel
NUS2401SNT1G	SC-74 (Pb-Free)	3000/Tape & Reel

†For information on tape and reel specifications, including part orientation and tape sizes, please refer to our Tape and Reel Packaging Specifications Brochure, BRD8011/D.

NUS2401SNT1

ELECTRICAL CHARACTERISTICS

(Unless otherwise noted: $T_J = 25^\circ\text{C}$ for typical values, common for Q1, Q2, and Q3, – minus signed for Q3 (PNP) omitted.)

Characteristic	Symbol	Min	Typ	Max	Unit
----------------	--------	-----	-----	-----	------

OFF CHARACTERISTICS

Collector–Base Cutoff Current ($V_{CB} = 50\text{ V}$, $I_E = 0$)	I_{CBO}	–	–	100	nAdc
Collector–Emitter Cutoff Current ($V_{CE} = 50\text{ V}$, $I_B = 0$)	I_{CEO}	–	–	500	nAdc
Emitter–Base Cutoff Current ($V_{CE} = 6.0\text{ V}$, $I_C = 0$)	I_{EBO}	–	–	500	μA
	Q3	–	–	0.1	
	Q1, Q2	–	–		
Collector–Base Breakdown Voltage ($I_C = 10\ \mu\text{A}$, $I_E = 0$)	$V_{(BR)CBO}$	50	–	–	V
Collector–Emitter Breakdown Voltage (Note 1) ($I_C = 2.0\text{ mA}$, $I_B = 0$)	$V_{(BR)CEO}$	50	–	–	V

ON CHARACTERISTICS (Note 1)

DC Current Gain	Q3	h_{FE}	35	60	–	
	Q1, Q2		150	350	–	
Collector–Emitter Saturation Voltage ($I_C = 10\text{ mA}$, $I_B = 0.3\text{ mA}$)	Q3	$V_{CE(sat)}$	–	–	0.25	Vdc
($I_C = 10\text{ mA}$, $I_B = 1.0\text{ mA}$)	Q1, Q2		–	–	0.25	
Output Voltage (on) ($V_{CC} = 5.0\text{ V}$, $V_B = 2.5\text{ V}$, $R_L = 1.0\text{ k}\Omega$)		V_{OL}	–	–	0.2	V
Output Voltage (off) ($V_{CC} = 5.0\text{ V}$, $V_B = 0.25\text{ V}$, $R_L = 1.0\text{ k}\Omega$)		V_{OH}	4.9	–	–	V
Input Resistor	Q3	R1	7.0	10	13	$\text{k}\Omega$
	Q1, Q2		0.13	0.175	0.22	
Resistor Ratio	Q3	R1/R2	–	1.0	–	
	Q1, Q2		–	∞	–	

1. Pulse Test: Pulse Width < 300 μs , Duty Cycle < 2%.

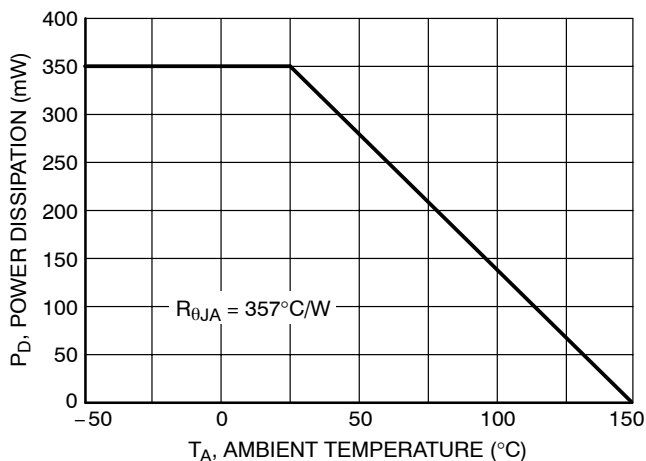

Figure 1. Derating Curve

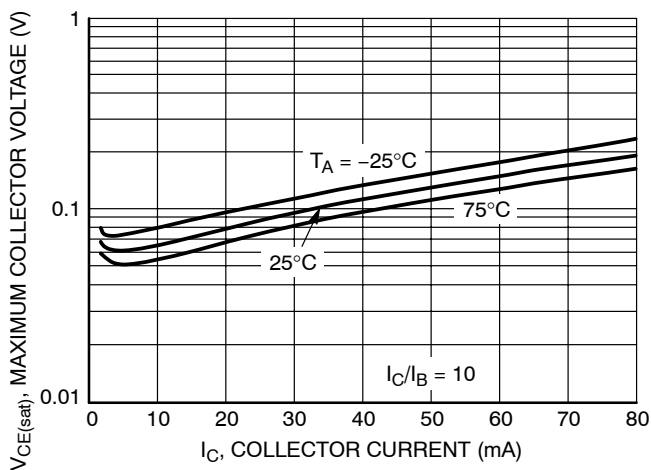

Figure 2. Maximum Collector Voltage versus Collector Current

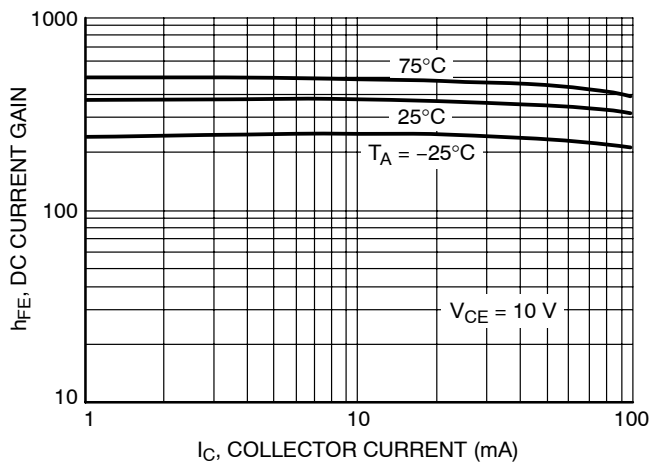

Figure 3. DC Current Gain

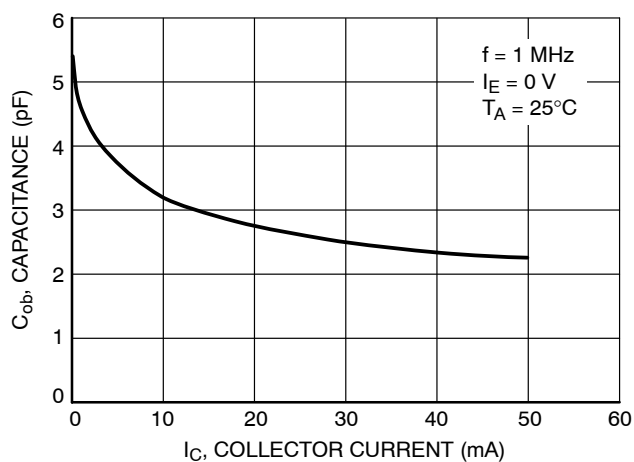

Figure 4. Output Capacitance

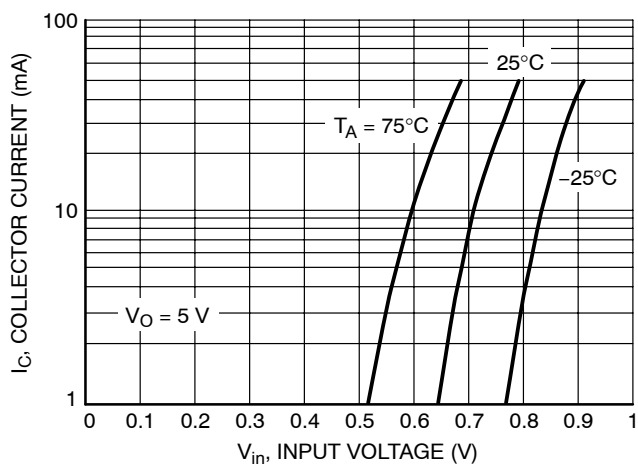

Figure 5. Output Current versus Input Voltage

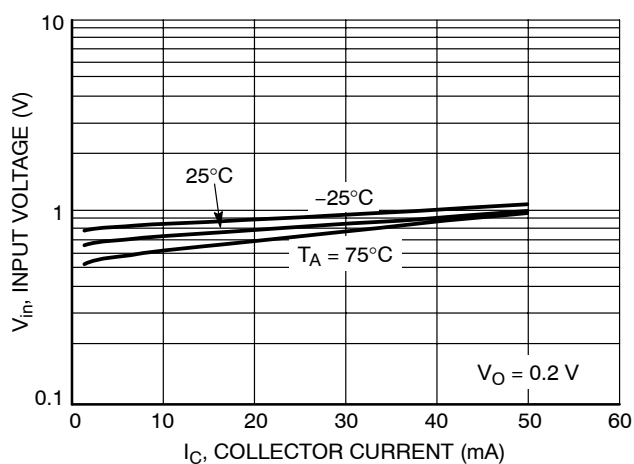

Figure 6. Input Voltage versus Output Current

NUS2401SNT1

TYPICAL ELECTRICAL CHARACTERISTICS – Q3 (PNP)

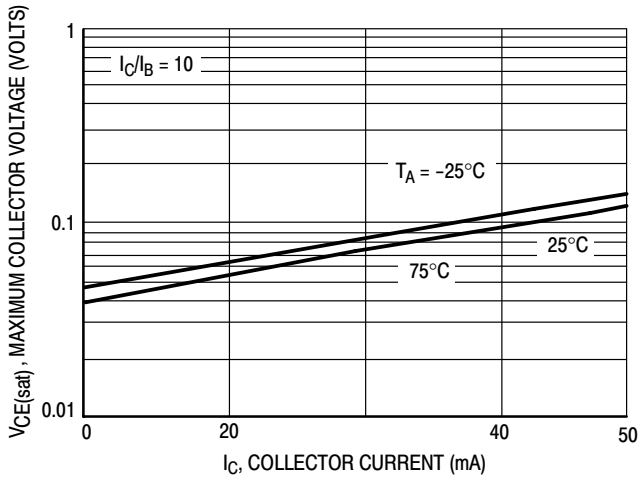

Figure 7. $V_{CE(sat)}$ versus I_C

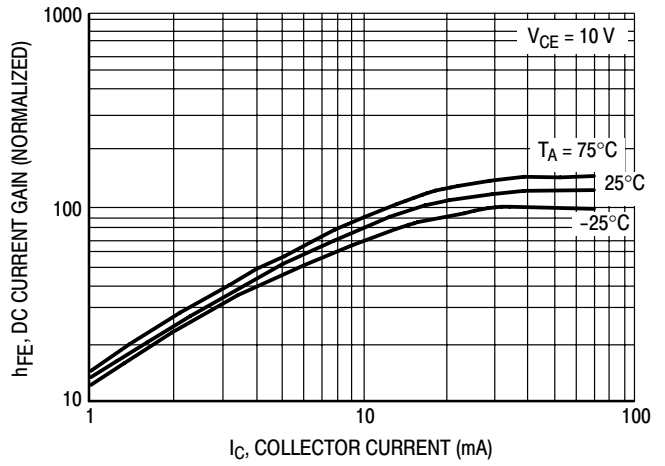

Figure 8. DC Current Gain

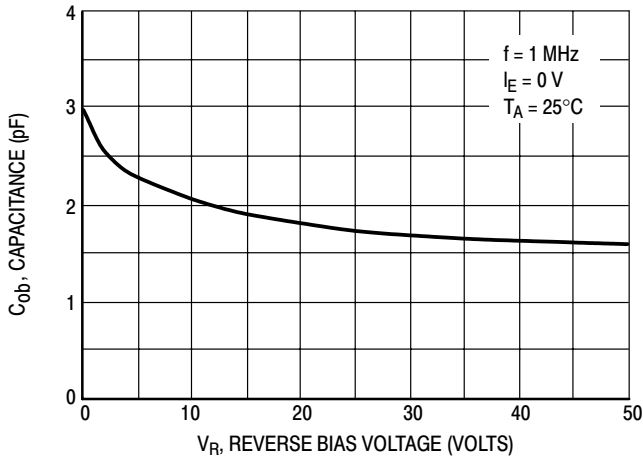

Figure 9. Output Capacitance

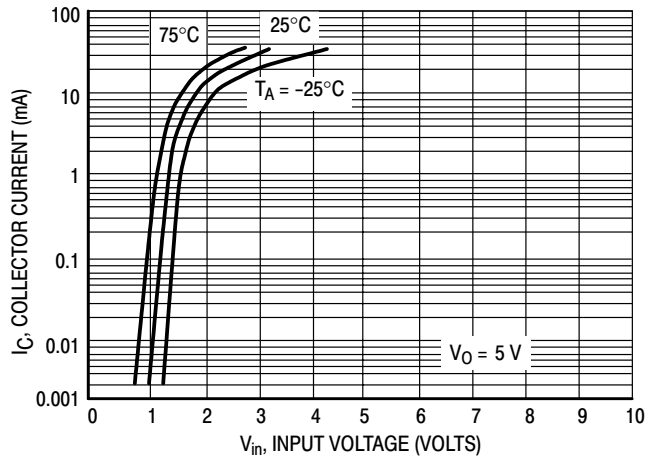

Figure 10. Output Current versus Input Voltage

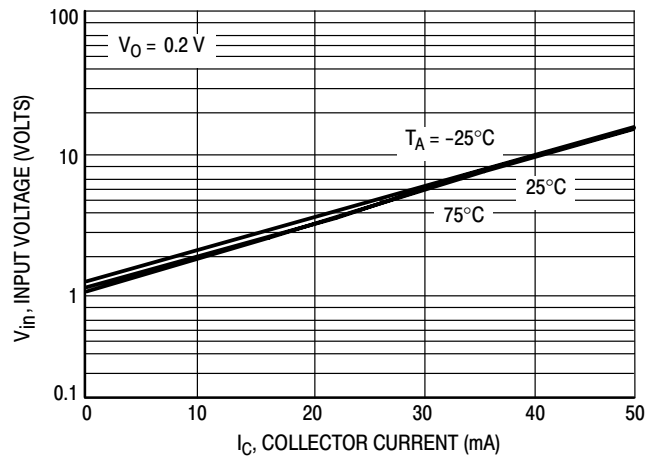
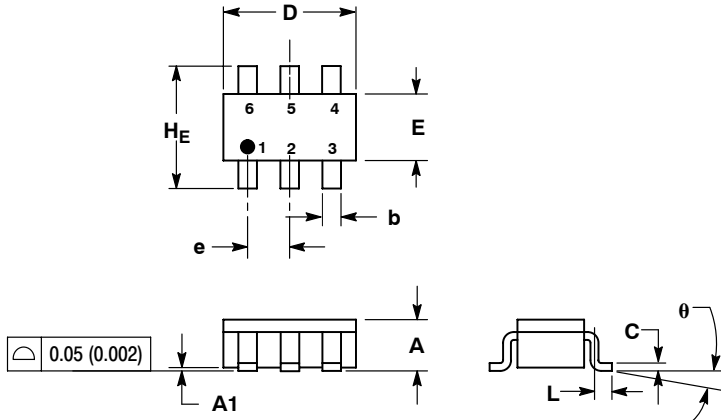

Figure 11. Input Voltage versus Output Current

NUS2401SNT1

PACKAGE DIMENSIONS

SC-74 CASE 318F-05 ISSUE L



NOTES:

1. DIMENSIONING AND TOLERANCING PER ANSI Y14.5M, 1982.
2. CONTROLLING DIMENSION: INCH.
3. MAXIMUM LEAD THICKNESS INCLUDES LEAD FINISH THICKNESS. MINIMUM LEAD THICKNESS IS THE MINIMUM THICKNESS OF BASE MATERIAL.
4. 318F-01, -02, -03 OBSOLETE. NEW STANDARD 318F-04.

DIM	MILLIMETERS			INCHES		
	MIN	NOM	MAX	MIN	NOM	MAX
A	0.90	1.00	1.10	0.035	0.039	0.043
A1	0.01	0.06	0.10	0.001	0.002	0.004
b	0.25	0.37	0.50	0.010	0.015	0.020
c	0.10	0.18	0.26	0.004	0.007	0.010
D	2.90	3.00	3.10	0.114	0.118	0.122
E	1.30	1.50	1.70	0.051	0.059	0.067
e	0.85	0.95	1.05	0.034	0.037	0.041
L	0.20	0.40	0.60	0.008	0.016	0.024
HE	2.50	2.75	3.00	0.099	0.108	0.118
θ	0°	-	10°	0°	-	10°

STYLE 4:

- PIN 1. COLLECTOR 2
2. EMITTER 1/EMITTER 2
3. COLLECTOR 1
4. EMITTER 3
5. BASE 1/BASE 2/COLLECTOR 3
6. BASE 3

SOLDERING FOOTPRINT*

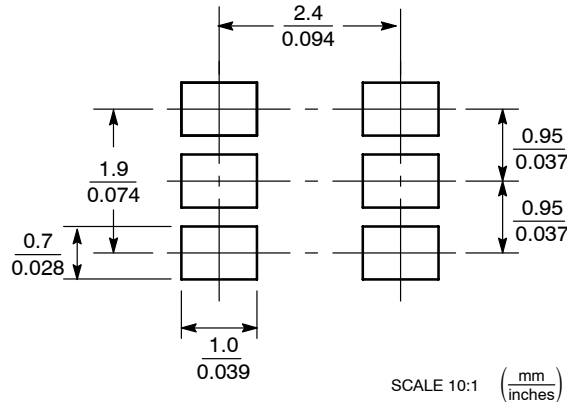

*For additional information on our Pb-Free strategy and soldering details, please download the ON Semiconductor Soldering and Mounting Techniques Reference Manual, SOLDERRM/D.

ON Semiconductor and are registered trademarks of Semiconductor Components Industries, LLC (SCILLC). SCILLC reserves the right to make changes without further notice to any products herein. SCILLC makes no warranty, representation or guarantee regarding the suitability of its products for any particular purpose, nor does SCILLC assume any liability arising out of the application or use of any product or circuit, and specifically disclaims any and all liability, including without limitation special, consequential or incidental damages. "Typical" parameters which may be provided in SCILLC data sheets and/or specifications can and do vary in different applications and actual performance may vary over time. All operating parameters, including "Typicals" must be validated for each customer application by customer's technical experts. SCILLC does not convey any license under its patent rights nor the rights of others. SCILLC products are not designed, intended, or authorized for use as components in systems intended for surgical implant into the body, or other applications intended to support or sustain life, or for any other application in which the failure of the SCILLC product could create a situation where personal injury or death may occur. Should Buyer purchase or use SCILLC products for any such unintended or unauthorized application, Buyer shall indemnify and hold SCILLC and its officers, employees, subsidiaries, affiliates, and distributors harmless against all claims, costs, damages, and expenses, and reasonable attorney fees arising out of, directly or indirectly, any claim of personal injury or death associated with such unintended or unauthorized use, even if such claim alleges that SCILLC was negligent regarding the design or manufacture of the part. SCILLC is an Equal Opportunity/Affirmative Action Employer. This literature is subject to all applicable copyright laws and is not for resale in any manner.

PUBLICATION ORDERING INFORMATION

LITERATURE FULFILLMENT:
Literature Distribution Center for ON Semiconductor
P.O. Box 61312, Phoenix, Arizona 85082-1312 USA
Phone: 480-829-7710 or 800-344-3860 Toll Free USA/Canada
Fax: 480-829-7709 or 800-344-3867 Toll Free USA/Canada
Email: orderlit@onsemi.com

N. American Technical Support: 800-282-9855 Toll Free
USA/Canada

Japan: ON Semiconductor, Japan Customer Focus Center
2-9-1 Kamimeguro, Meguro-ku, Tokyo, Japan 153-0051
Phone: 81-3-5773-3850

ON Semiconductor Website: <http://onsemi.com>

Order Literature: <http://www.onsemi.com/litorder>

For additional information, please contact your local Sales Representative.